

im**possible**
furniture

IXO

Index

Lounge Chair LC-1	5
Table Collection Xlim	27
Armchair & Sofa AC-1	43
Sideboard Collection XForm	57
Kitchen Collection KC-1	93
Standard Colors	110

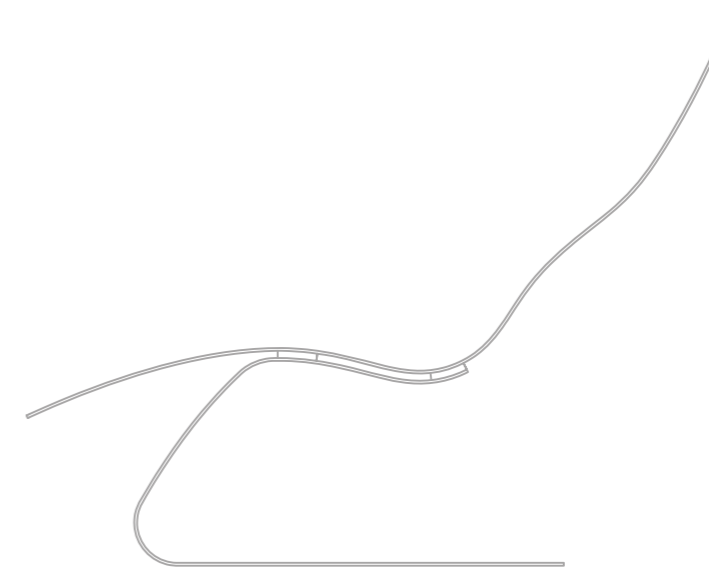

Lounge Chair **LC-1**



Matte carbon fiber, black leather,
metal pieces in black anodized aluminium.



Pearl white paint, white leather,
metal pieces in black anodized aluminium.

Slim Elegance

Utilising the extreme capabilities of carbon fiber, we have designed a sleek yet elegant form. At only 6mm thick, including the finishing, the LC-1 blends 4 different fabrics, to obtain something unique, beautiful and ethereal.

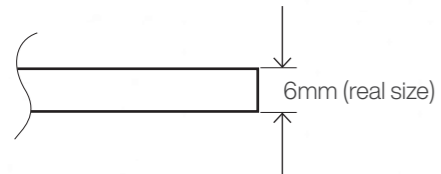

Pure and Simple

We have embraced simplicity, using few materials to create the LC-1: carbon fiber, anodized aluminium and 6 titanium screws.

Together with the optional premium-class aniline leather, there is no finer combination.





Black carbon fiber, aniline leather,
metal pieces in natural aluminium.



Embossed logo on leather.



Metal counterweight for headrest
height compensation.

Customizable Aesthetic

You are in control. Each piece is hand crafted allowing for unparalleled finishes. From the full richness of carbon weaves to metallic transparent tints, or even chameleon colours, the choice is yours.

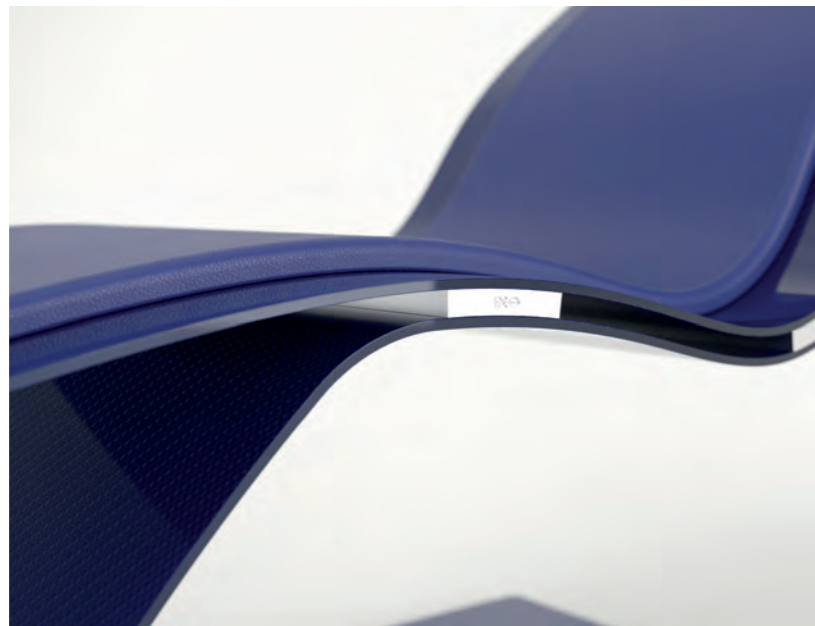

Blue carbon fiber, blue leather,
metal pieces in natural aluminium.

Black Series

A sophisticated matte finish combined with black, hand brushed, anodized aluminium and black leather makes a serious colour palette for those seeking something truly distinct.



Matte carbon fiber, black leather, metal pieces in black anodized aluminium.

Limitless Combinations

Colours are almost infinite, and the integration of finishes, carbon, paint, leather, stitching and metal are endless. Let us create the ultimate centrepiece for your chosen space.



White paint, edges unpainted. Metal pieces in black.



Ruby red carbon fiber with
black leather, red stitching.

Technical Sheet

Approximate weight (not including leather): 25 kg.

Packaging: 1 units in strong cardboard box with cushioned reinforcements inside.

The piece is delivered unassembled for transport purposes. The LC-1 is supplied with 6 titanium screws for a simple assembly upon arrival.

Aniline leather made in Austria, with Poron XRD® viscoelastic foam.

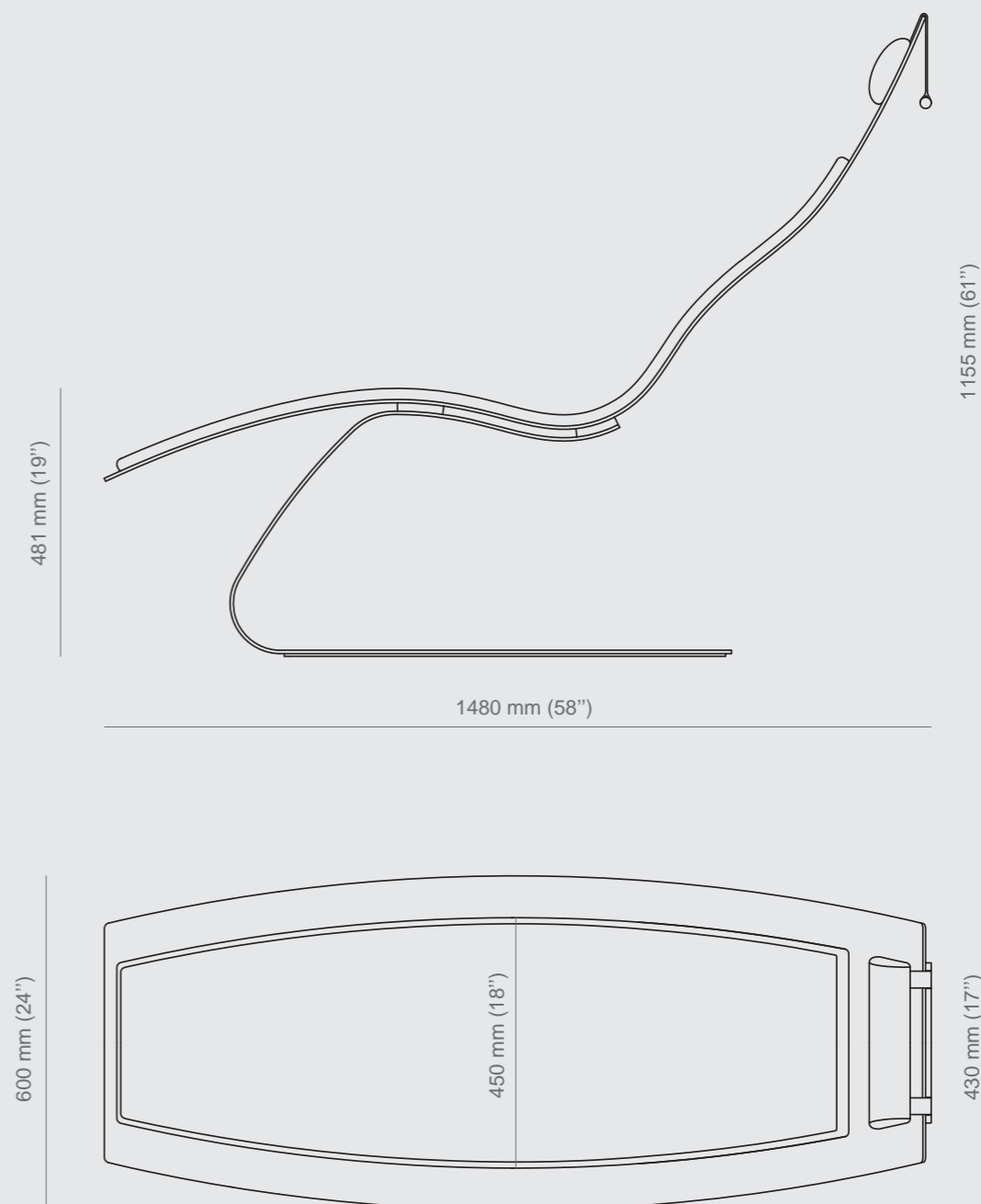



Table Collection **Xlim**





Glossy carbon fiber

Extreme Slimness

Carbon fiber provides us the possibility of outstanding physical performance, but considering a great stability and comfort.



Slick finish

With no visible screws, each line follows the curated design to deliver a unique piece.

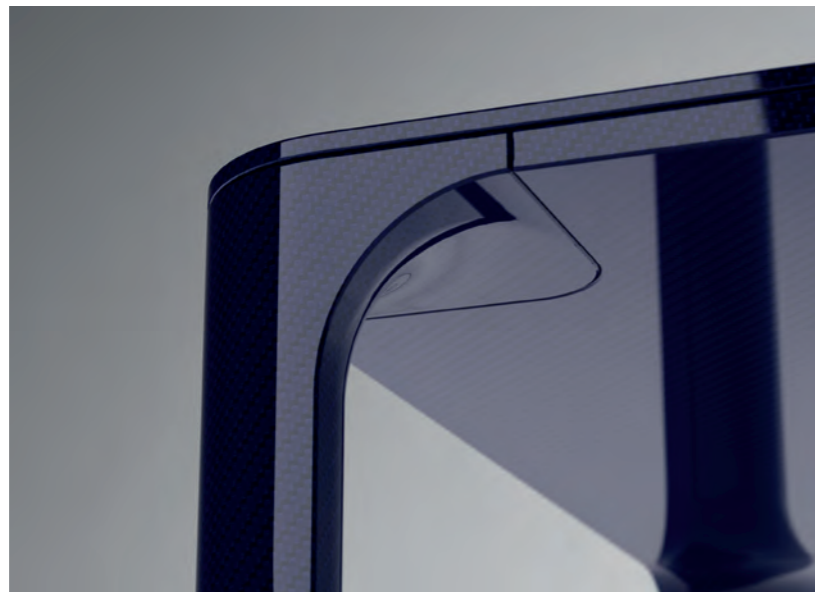

Blue Glossy Carbon Fiber



Matte Black Carbon Fiber

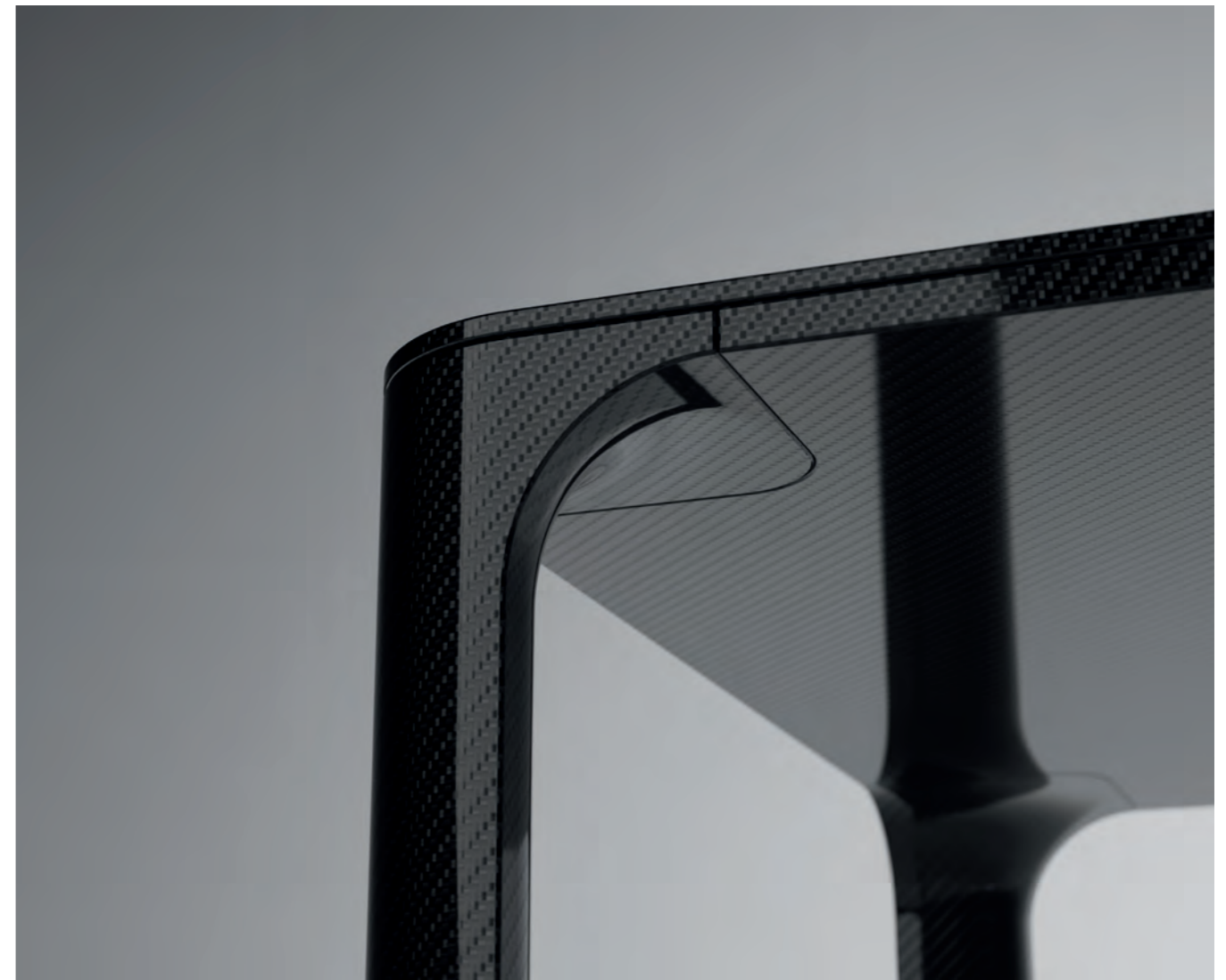

All the finishes you can imagine

The sky is the limit, the body can be painted in any color, and for the top piece, there is no limitation: CarbonGlass®, Marble, Wood...



Meet the family

We present 5 standard models, but we can manufacture the Xlim in any dimension. Just contact us.



Coffee Table
1200 x 1200mm



Coffee Table
1000 x 1000mm



Dining Table
1200 x 3000mm



Dining Table
1100 x 2500mm



Dining Table
1000 x 2000mm

Technical Sheet

Packaging: 1 units in strong cardboard box with cushioned reinforcements inside.

The piece is delivered unassembled for transport purposes.

Easy and fast assembly.

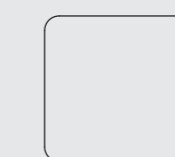
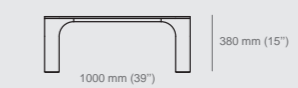
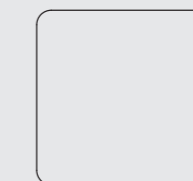
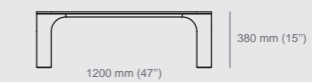
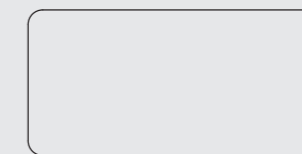
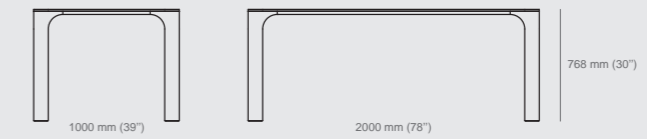
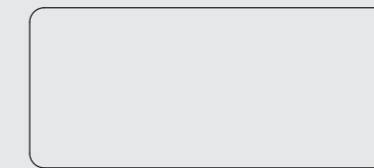
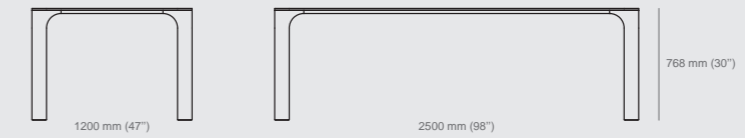
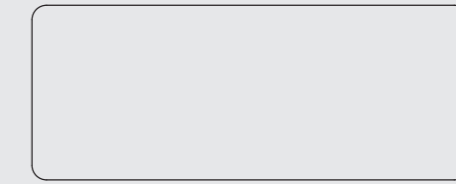
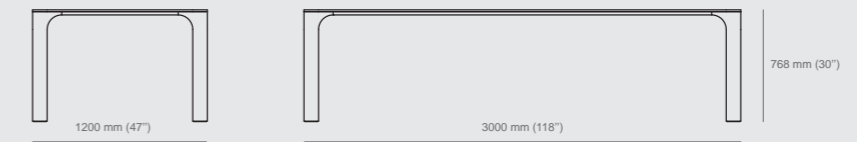

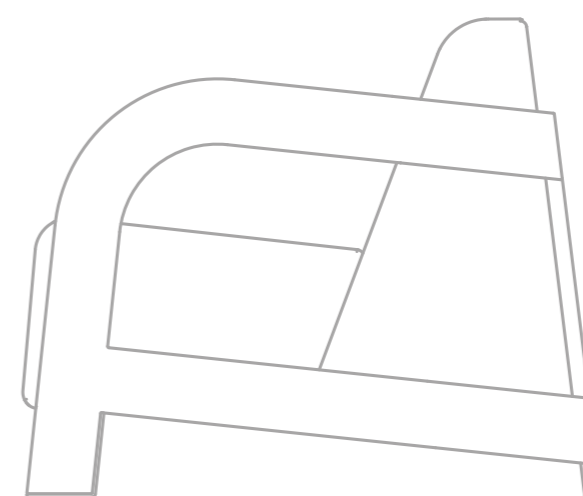

Armchair / Sofa **AC-1**



Glossy carbon fiber, white leather,
metal pieces in natural brushed aluminium.



Glossy carbon fiber, white leather,
metal pieces in natural brushed aluminium.

Design and character

A classic desing, revised. The structure, made in carbon fiber, conveys a collection of armchair and sofas that fit perfectly in the most exclusive spaces.



Details

All the connections between materials are carefully designed, in order to hide any screw, and provide a clean and sophisticated look.



3 sizes

The smart design of the armchair allows us to offer it in any size, for any number of seats.



Technical Sheet

Aniline leather, made in Austria, with Poron XRD® viscoelastic foam.

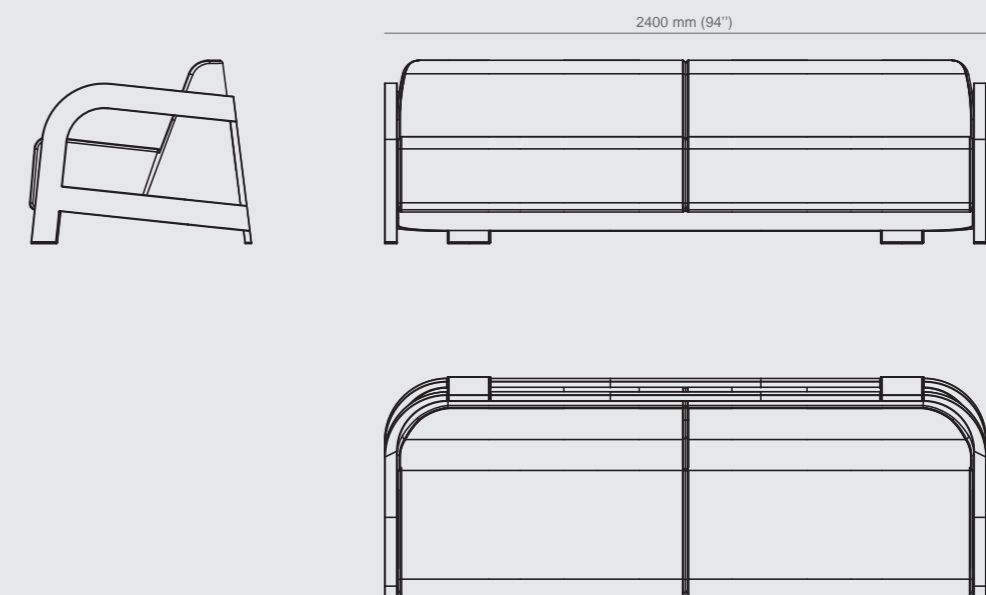
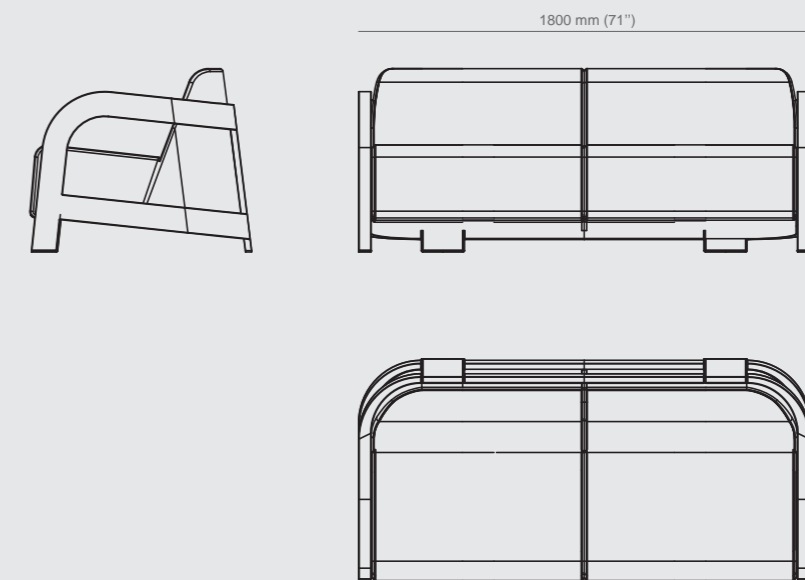
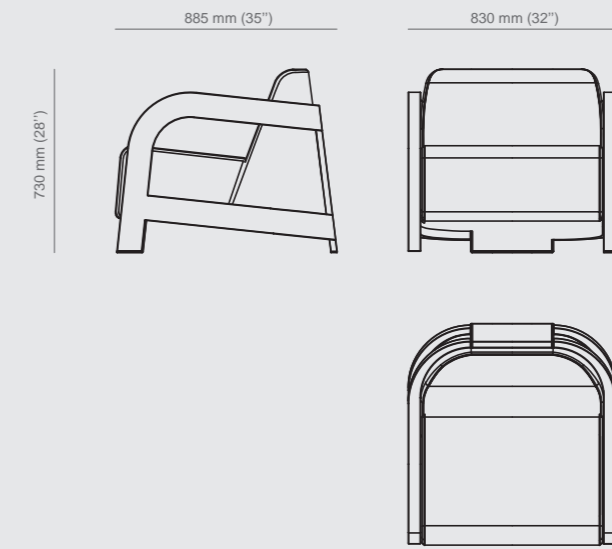

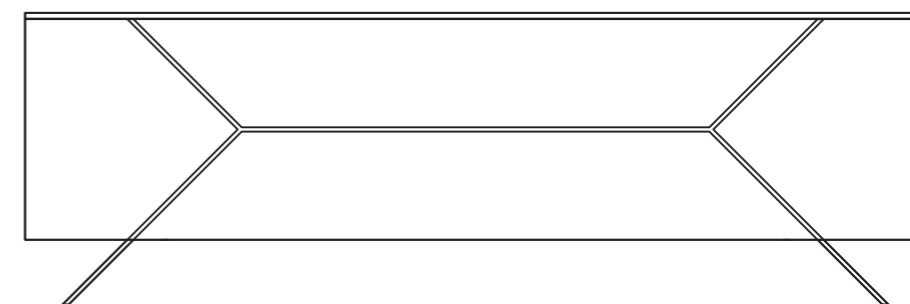

Sideboard collection **XForm**

XForm collection

Sideboard - Bar

Sideboard

Tv Unit

China Unit

Cabinet

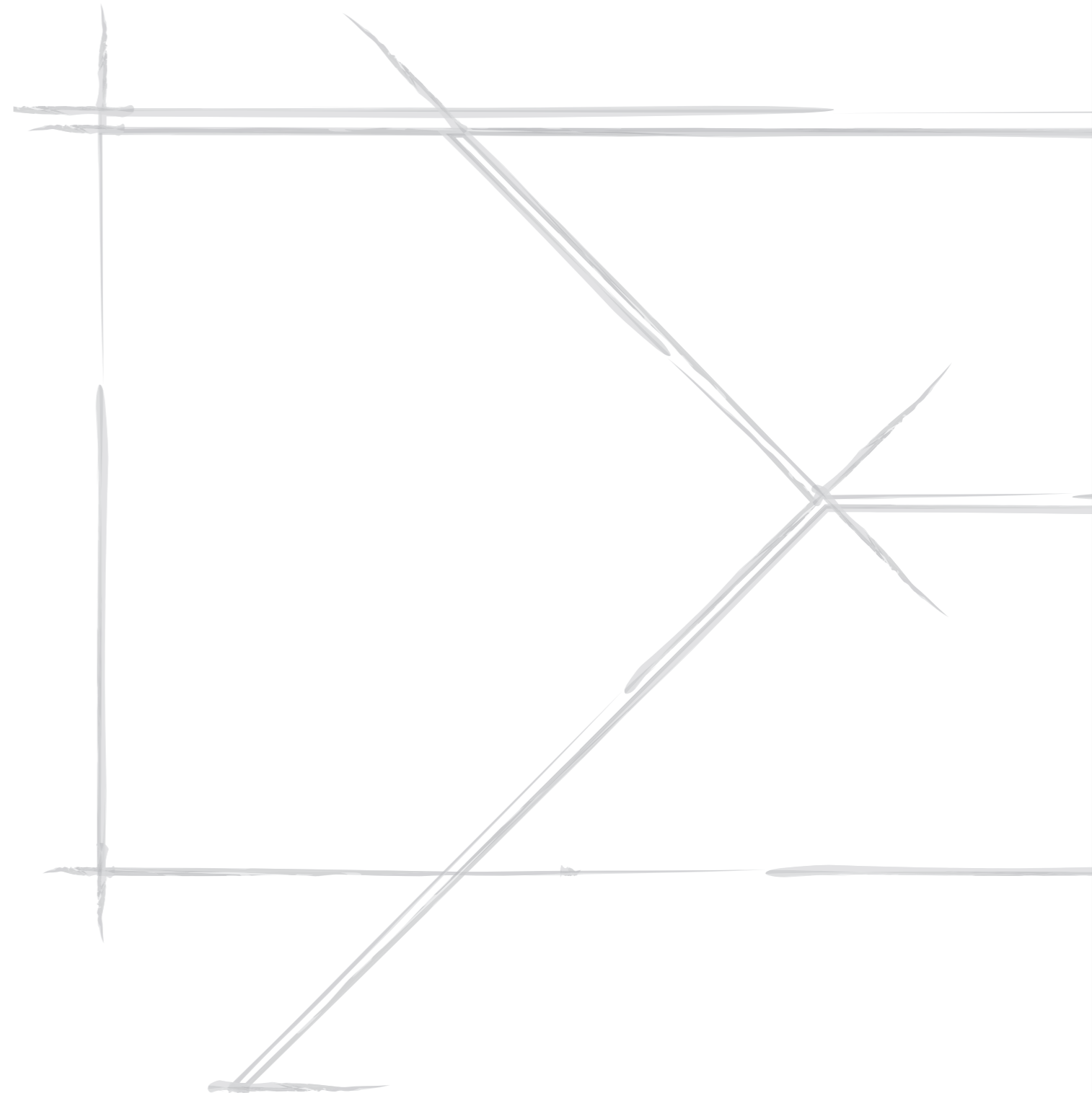

Sideboard Bar



Sideboard Bar

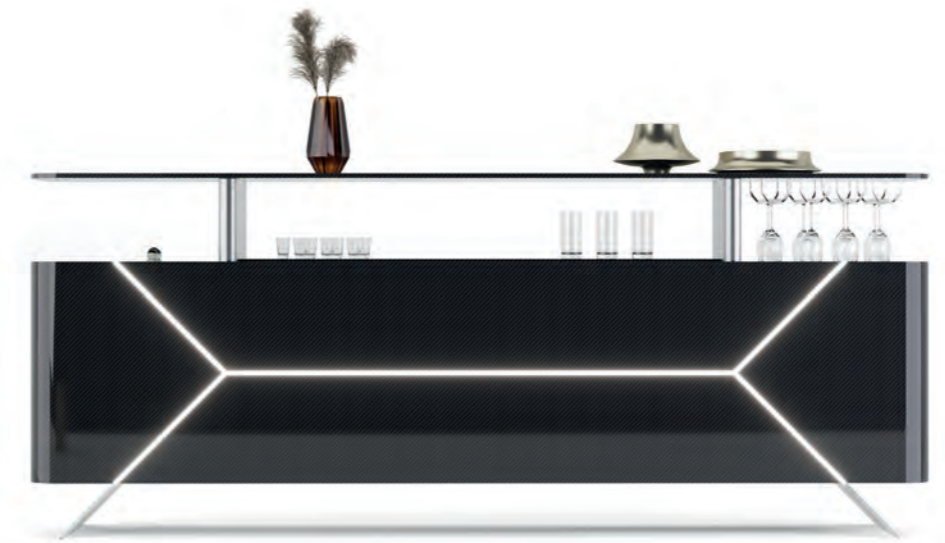

Sideboard Bar

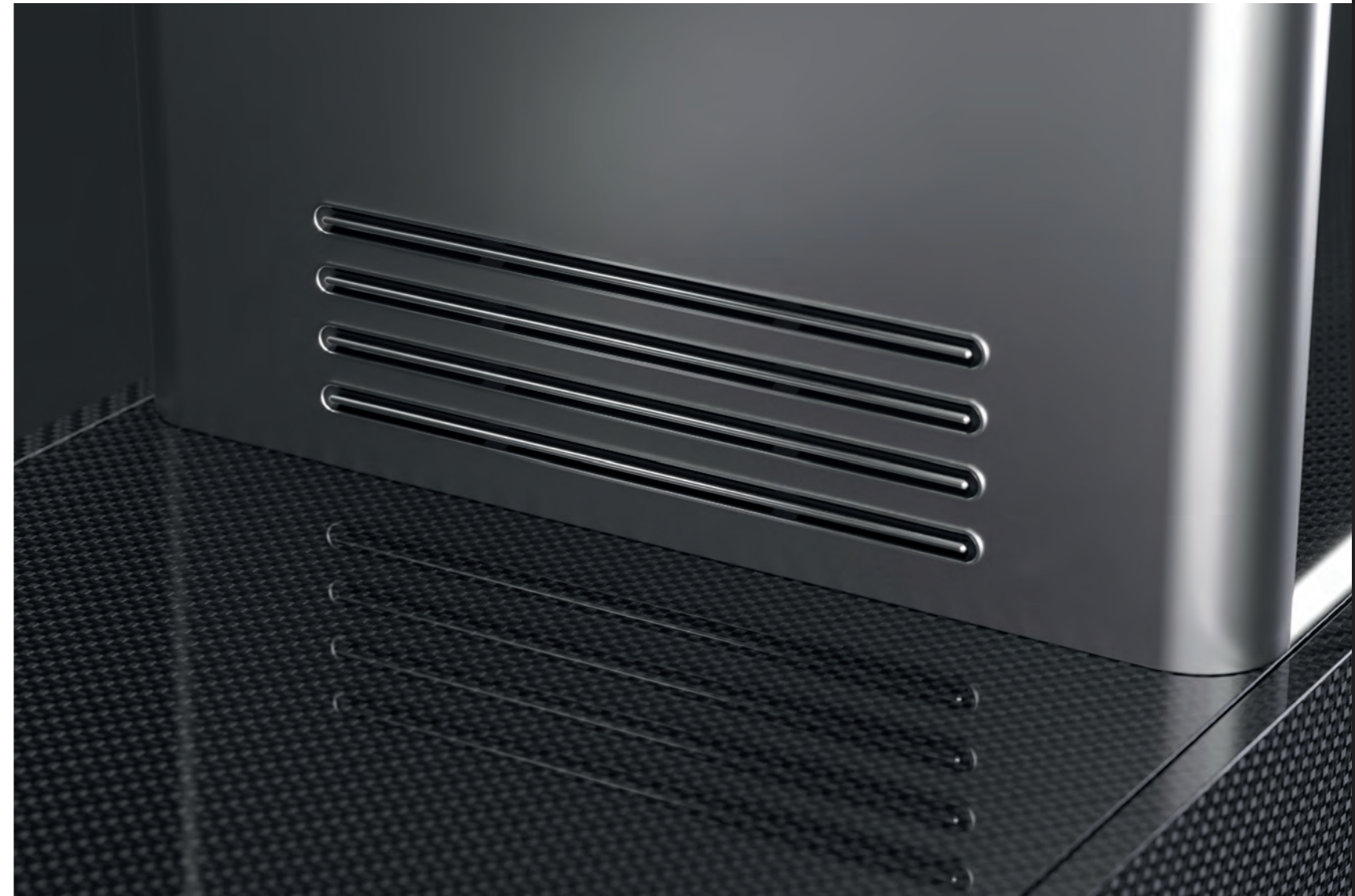

Optional cooling system

Sideboard Bar

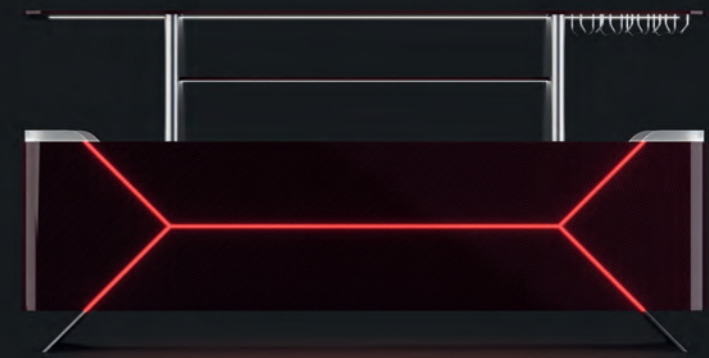

Night Mode.
Each carbon color
matches light tone.

Sideboard



Sideboard

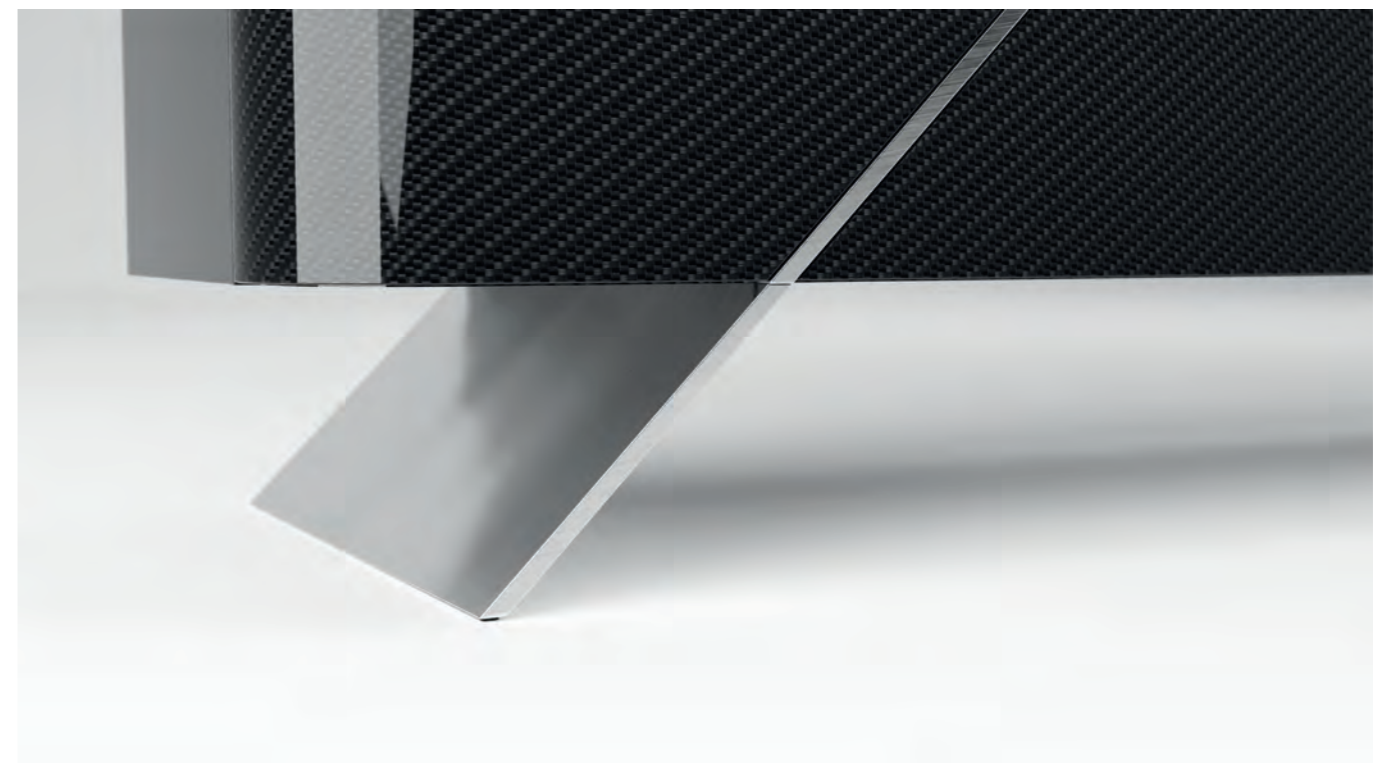
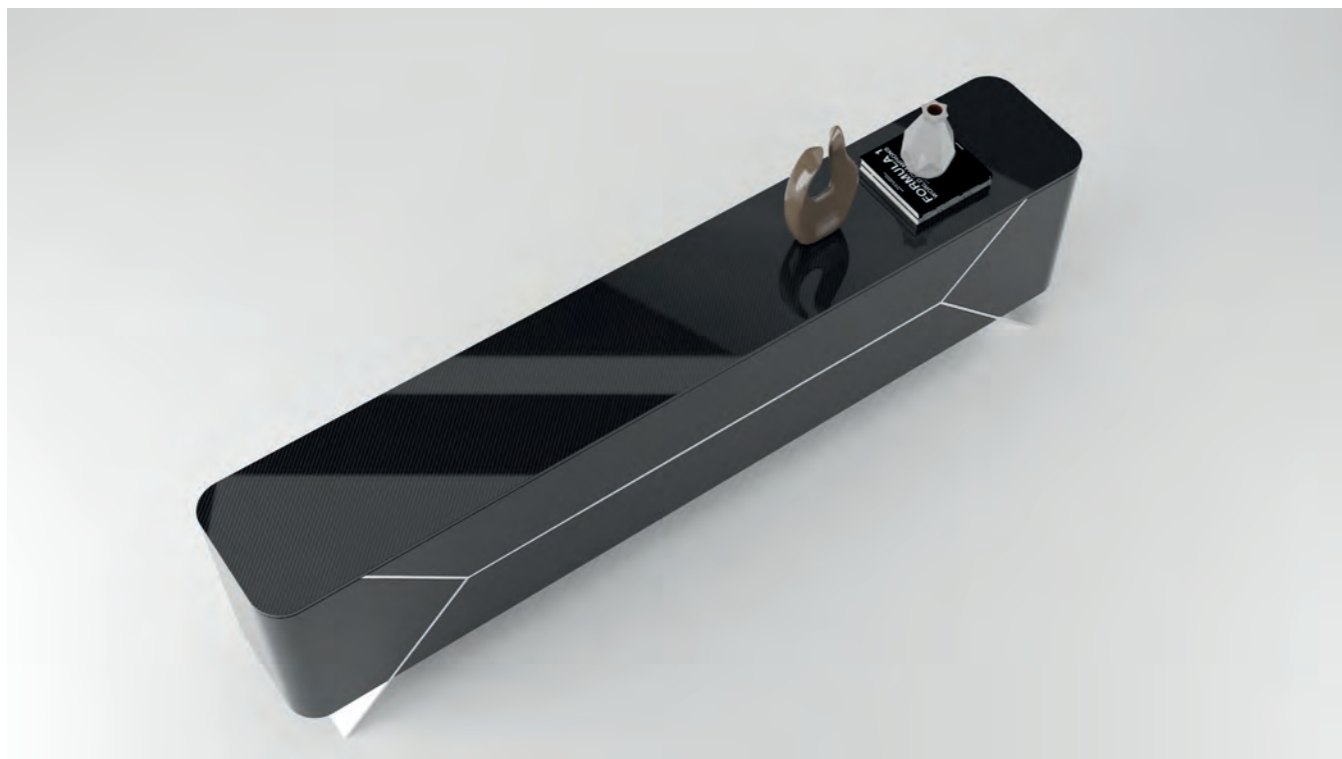
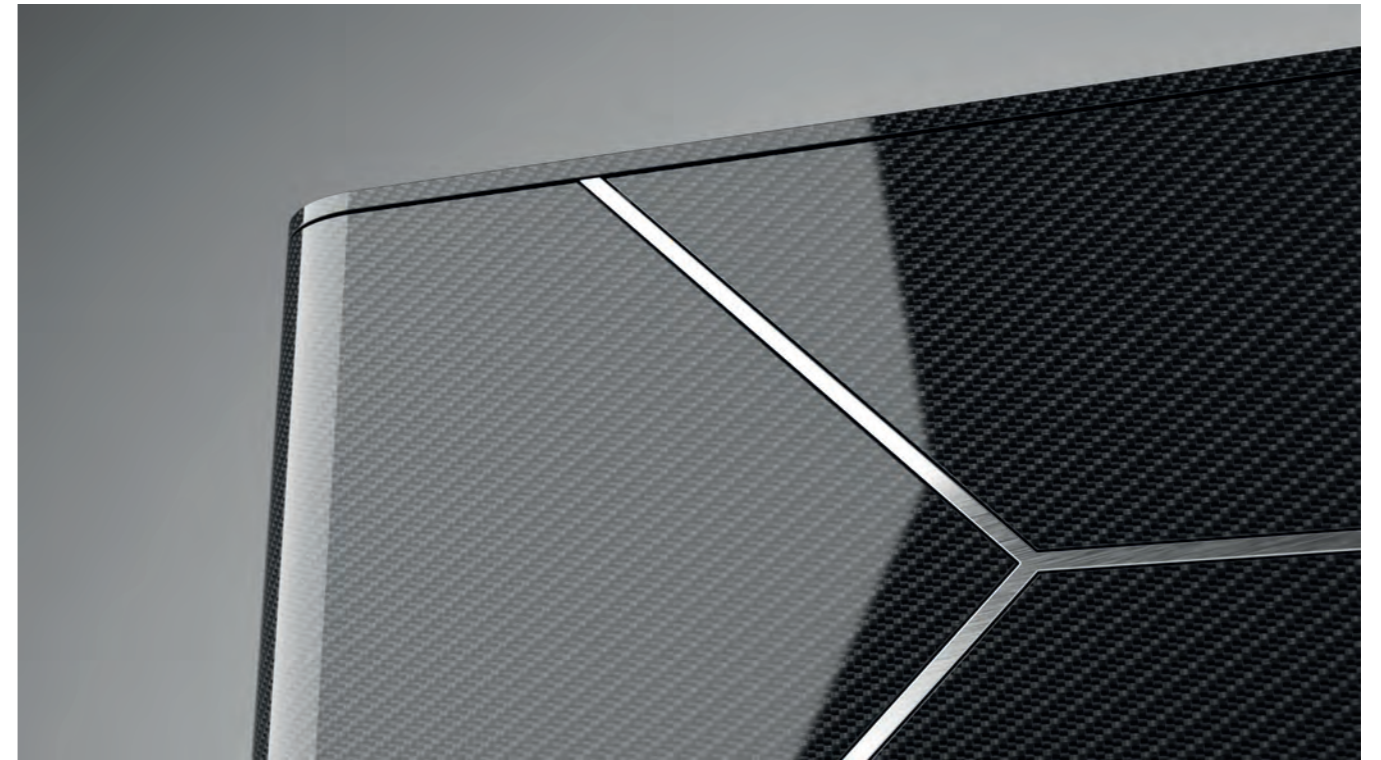

TV Unit



TV Unit

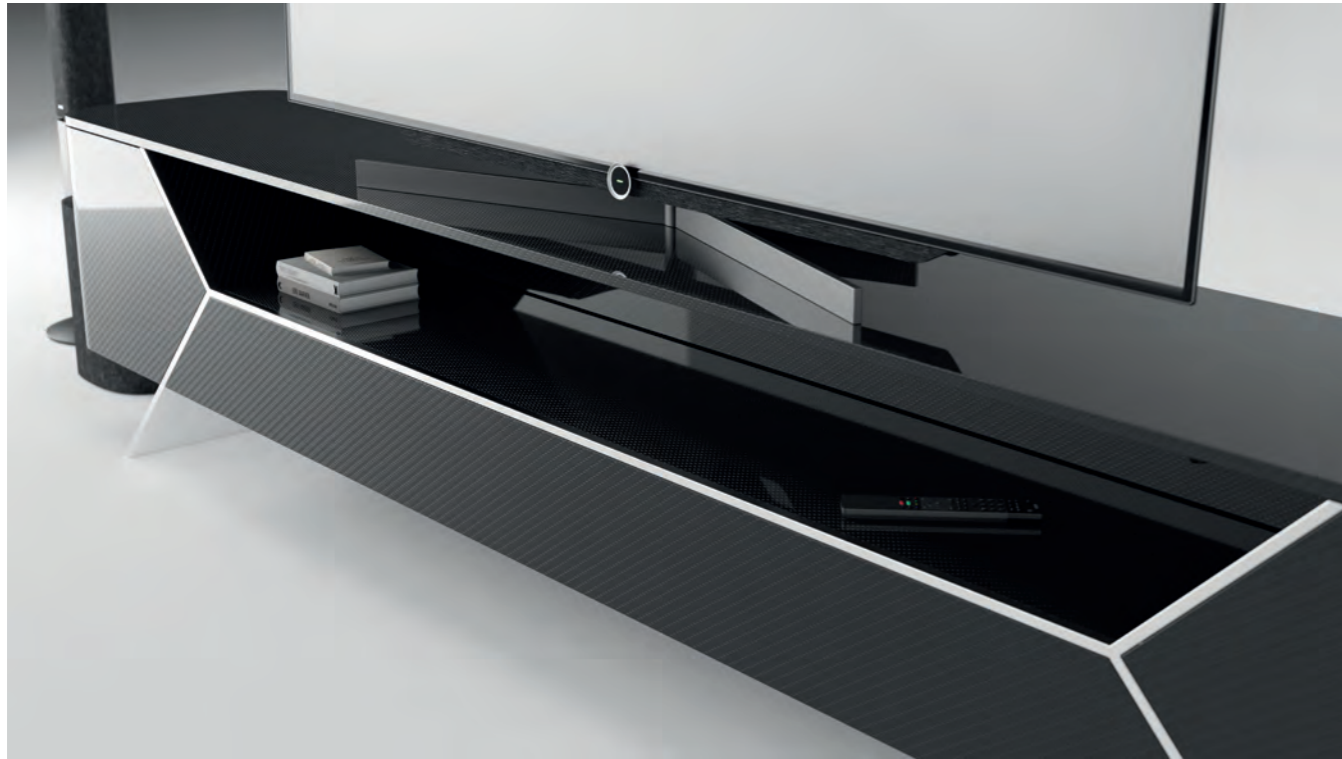

China Unit



China Unit

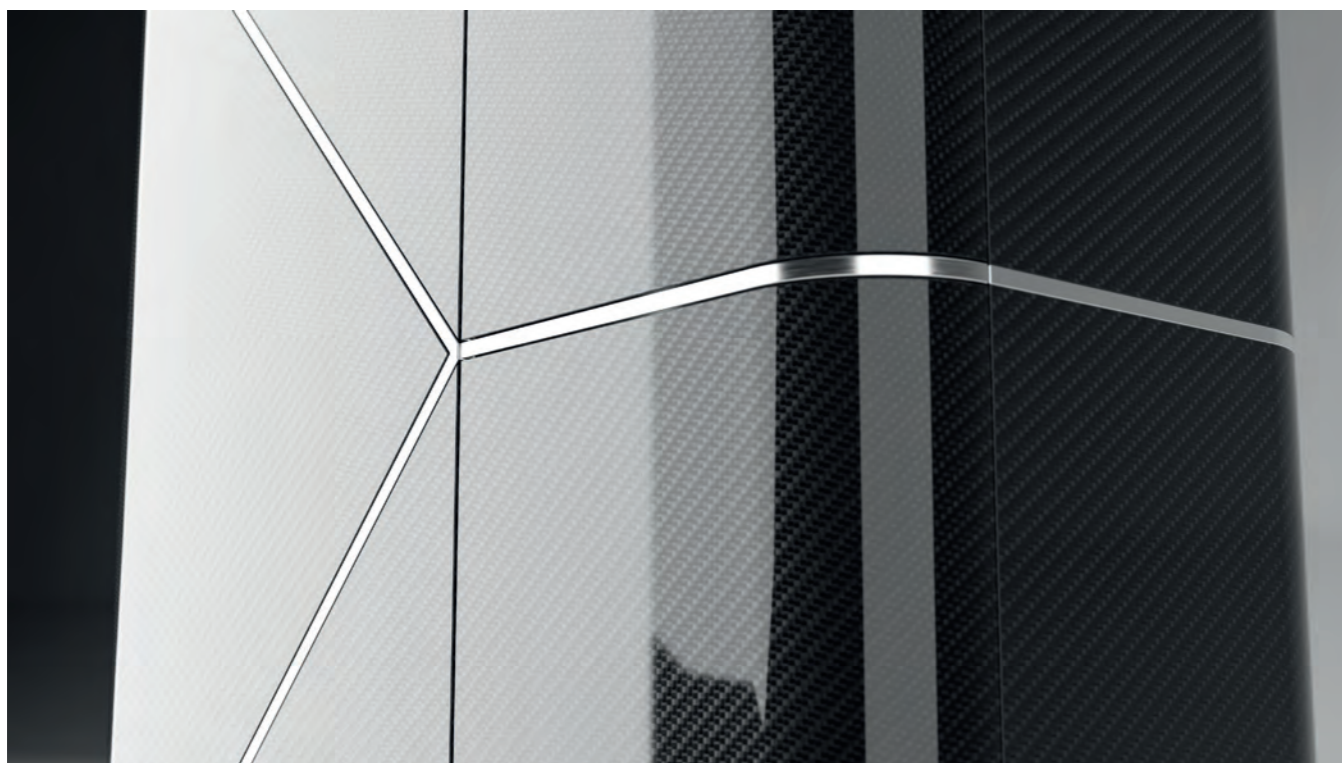

Cabinet

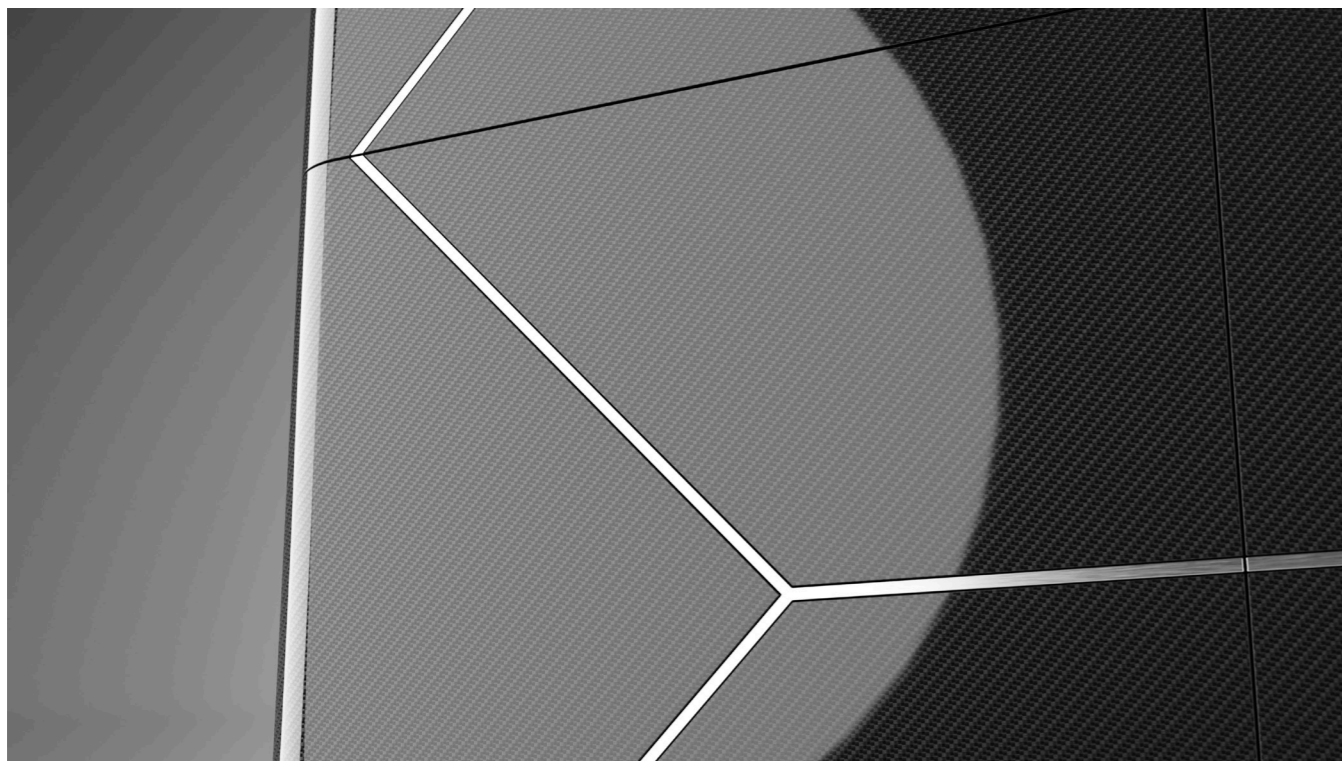

Technical Sheet

Sideboard - bar

Cabinet with motorized lift-up shelf , and optional cooling system.
Interior shelves in carbon fiber with integrated LED lighting.
Exterior LED lighting in matching color.

Legs in brushed anodized T6 aluminium.

1 standard size, optional custom design. Exterior finishes customizable in colour.

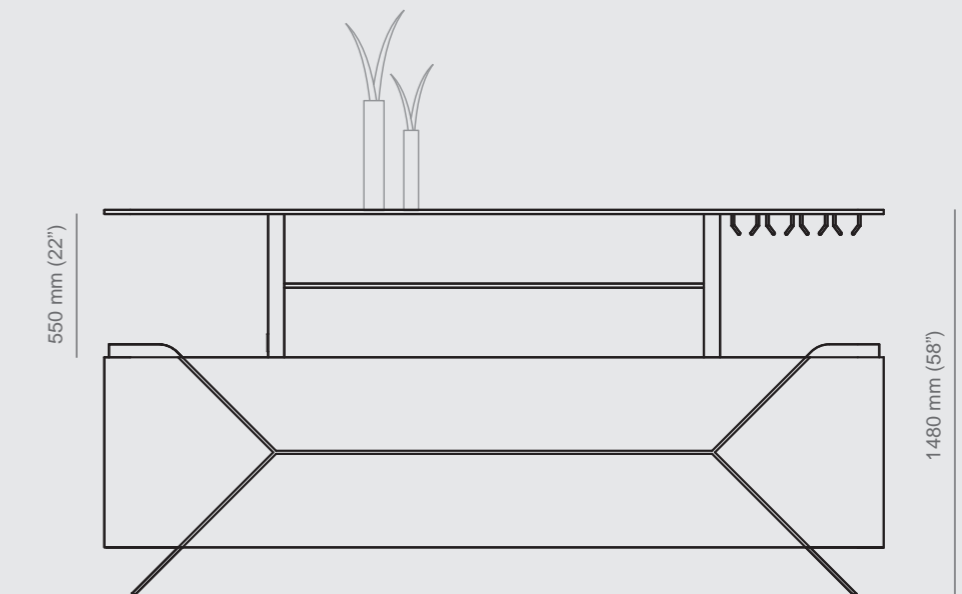
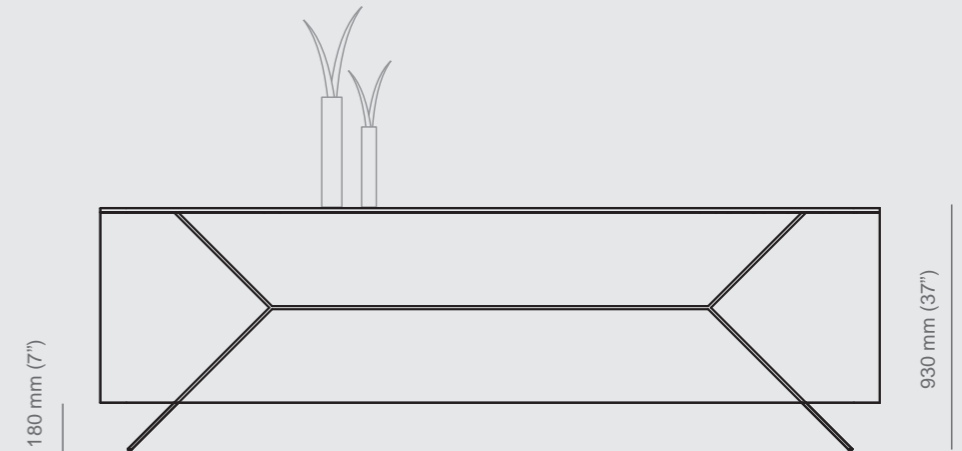
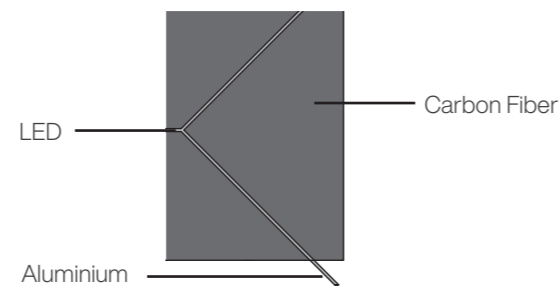

Technical Sheet

Sideboard

Sideboard 2 doors, 2 automatic drawers. Structure and doors in carbon fiber, top in carbon fiber. Legs in brushed anodized T6 aluminium. Interior shelves in CarbonGlass®.

3 standard sizes, optional custom design. Exterior finishes customizable in colour.

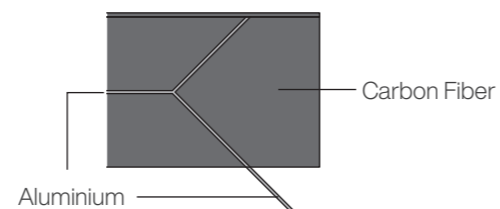
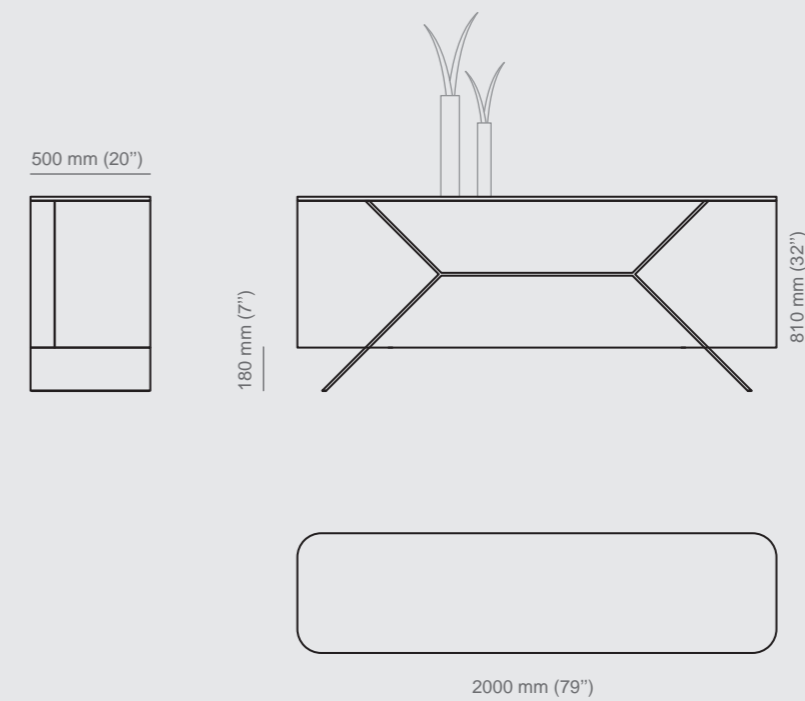
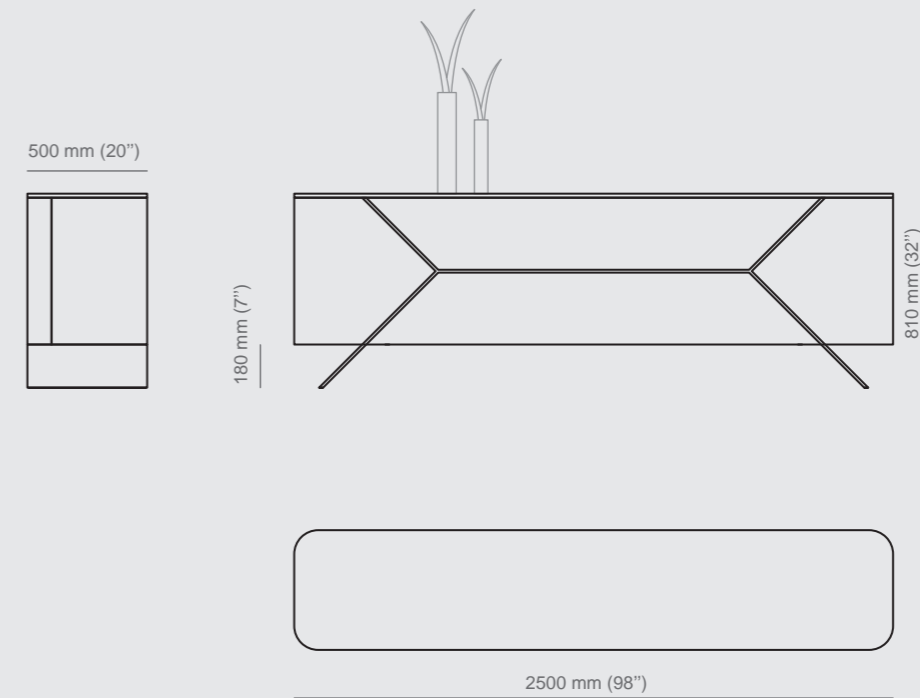
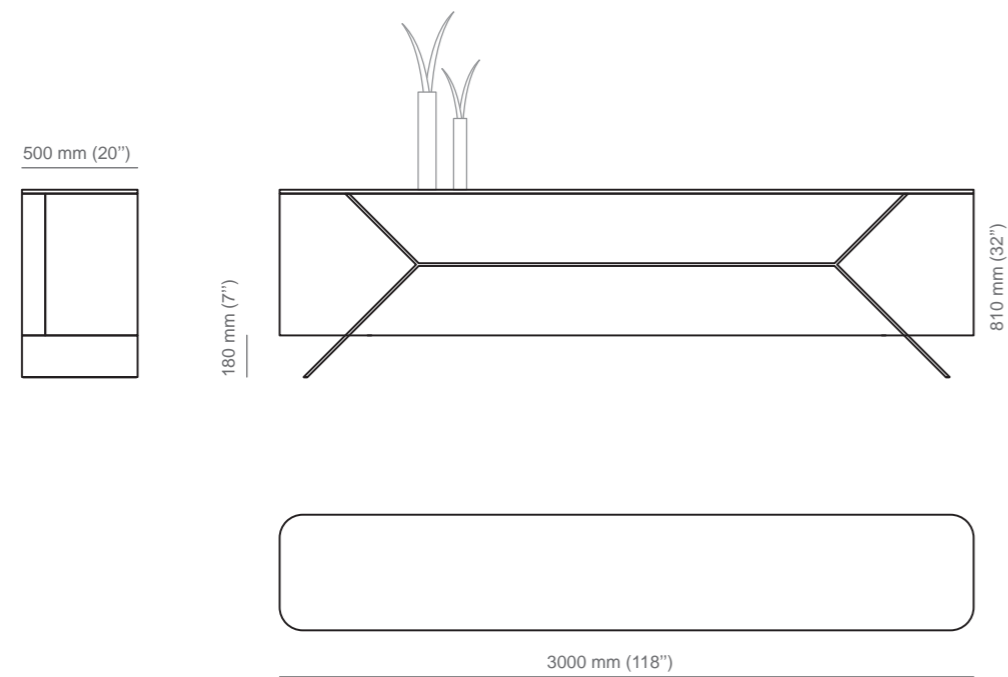

Technical Sheet

TV Set

Tv Unit with 2 doors, 1 automatic drawer (bottom), 1 open shelf. Structure and doors in carbon fiber, top in carbon fiber. Legs in brushed anodized T6 aluminium. Interior shelves in CarbonGlass®.

Integrated hidden cable management.

3 standard sizes, optional custom design. Exterior finishes customizable in colour.

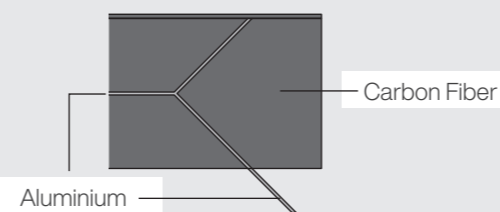
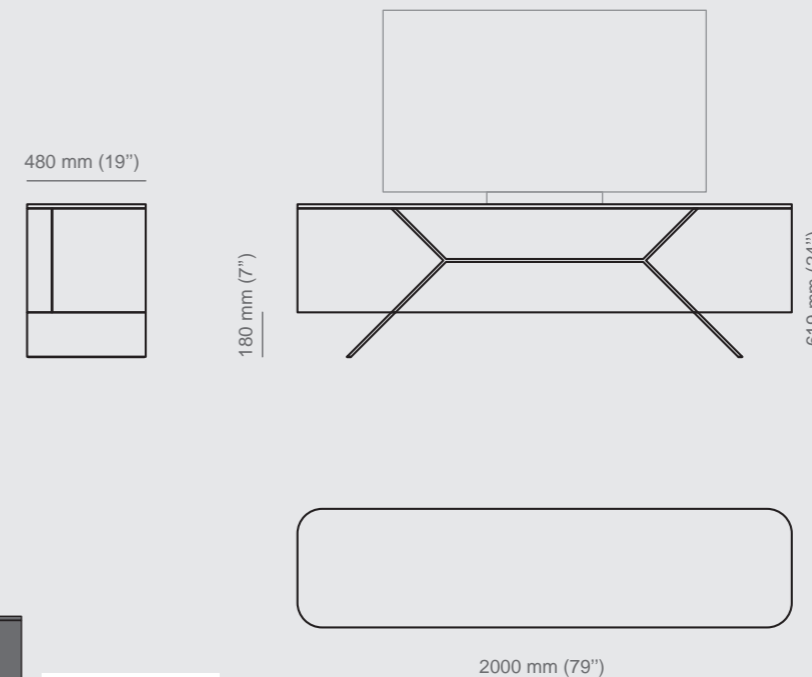
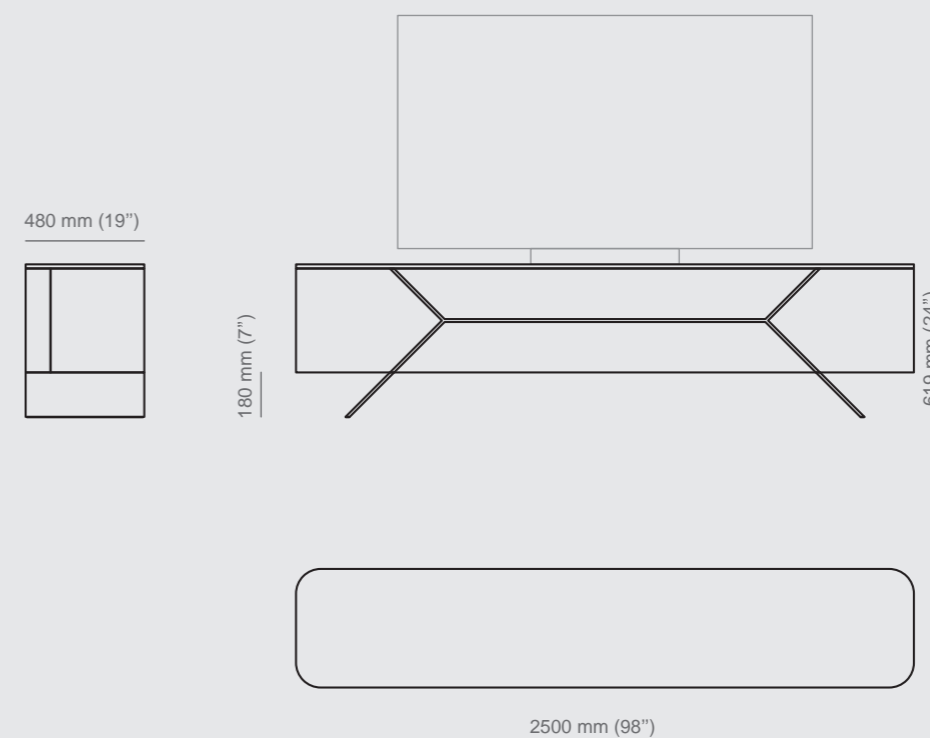
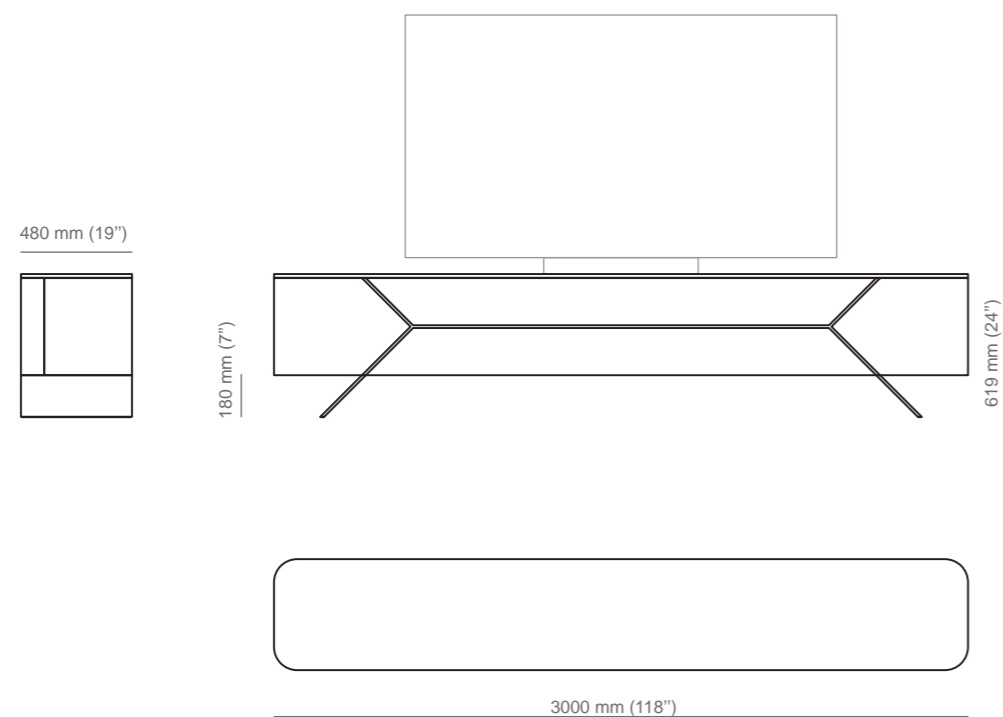

Technical Sheet

China unit

Cabinet or china unit with 2 doors. Structure and doors in carbon fiber, top in carbon fiber. Legs in brushed anodized T6 aluminium. Interior shelves in CarbonGlass®.

2 standard sizes, optional custom design. Exterior finishes customizable in colour.

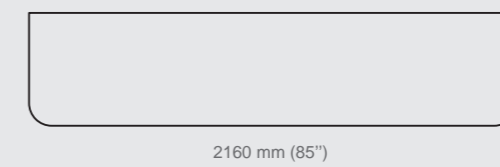
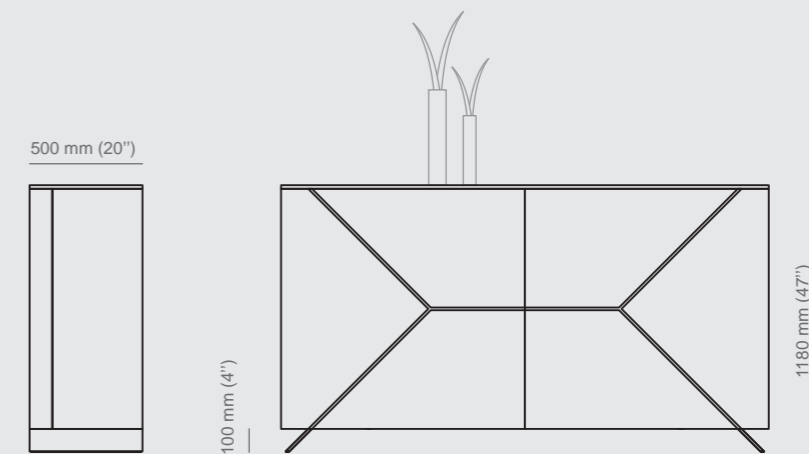
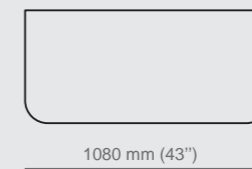
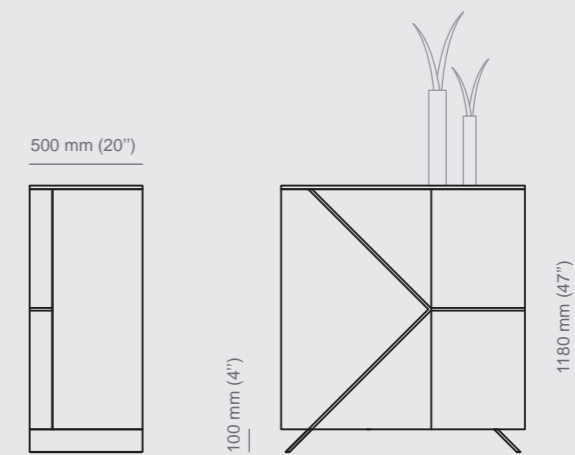
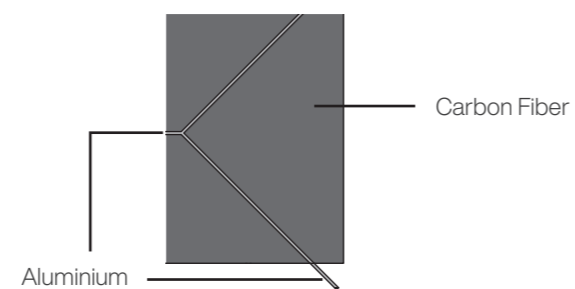

Technical Sheet

Cabinet

Cabinet with 4 doors. Structure and doors in carbon fiber.
Legs in brushed anodized T6 aluminium. Interior shelves in CarbonGlass®.

1 standard size, optional custom design. Exterior finishes customizable in colour.

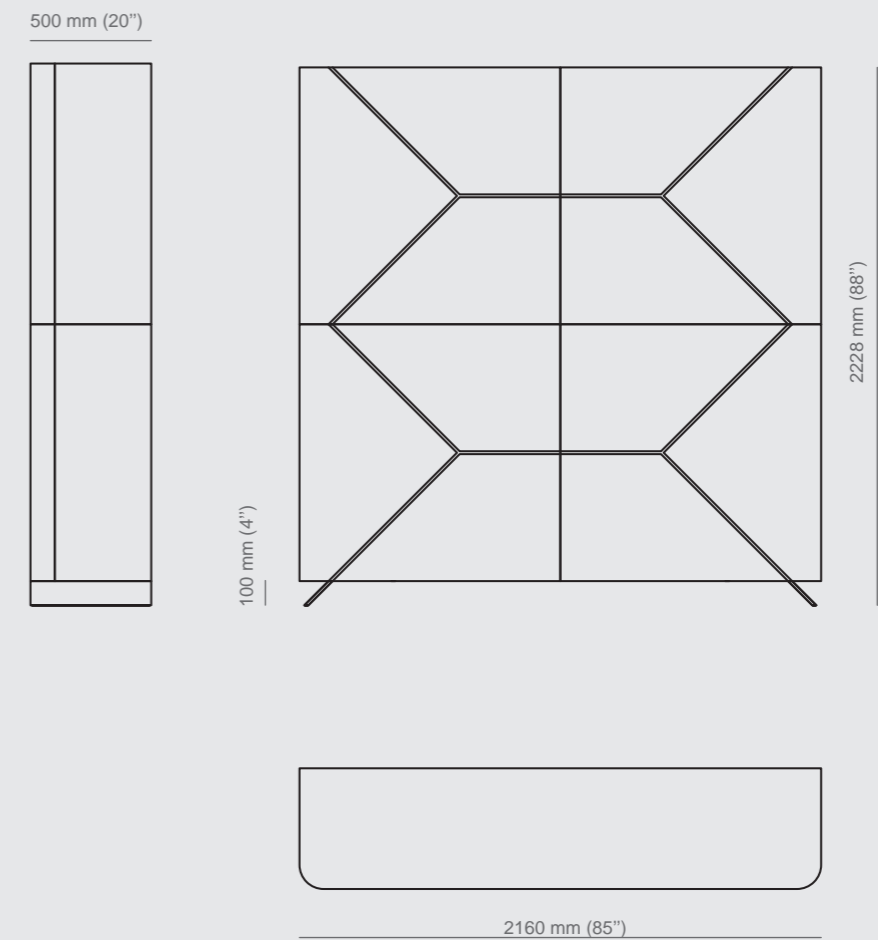
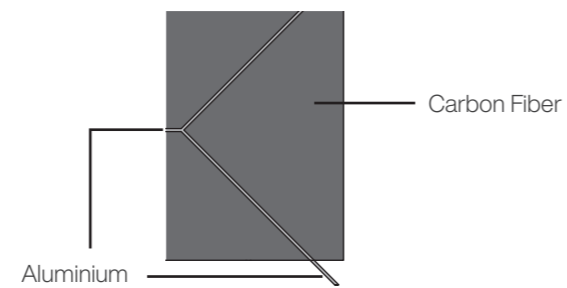

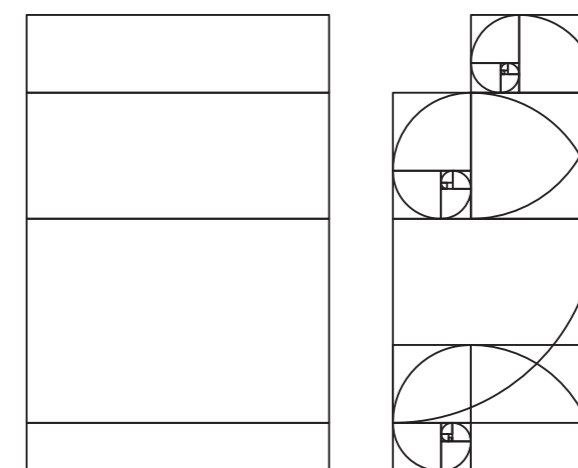

Kitchen Collection **KC-1**



Black carbon fiber,
stainless steel countertops.





Old cognac carbon fiber,
stainless steel countertops.







Shapphire blue metallic carbon fiber,
marble countertops.





Stainless steel motorized drawers.



Standard Carbon Fiber Finishes

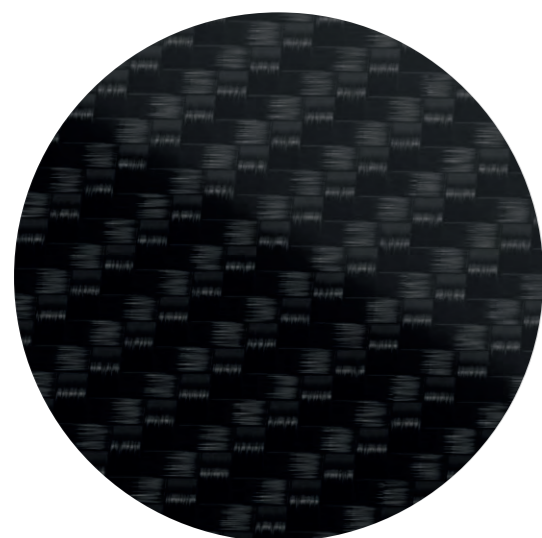

Black

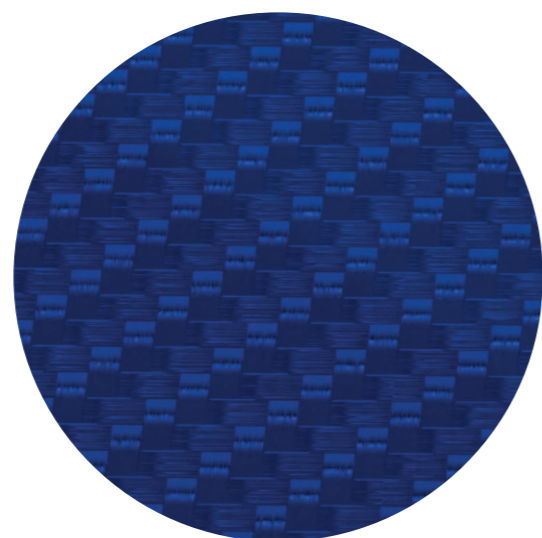

Shaphire Blue Metallic

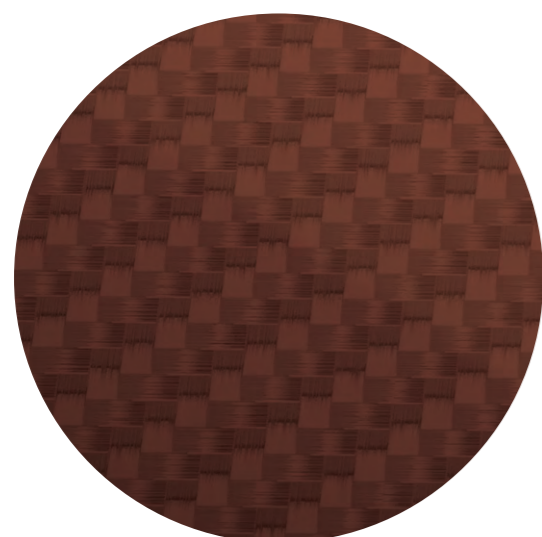

Old Cognac

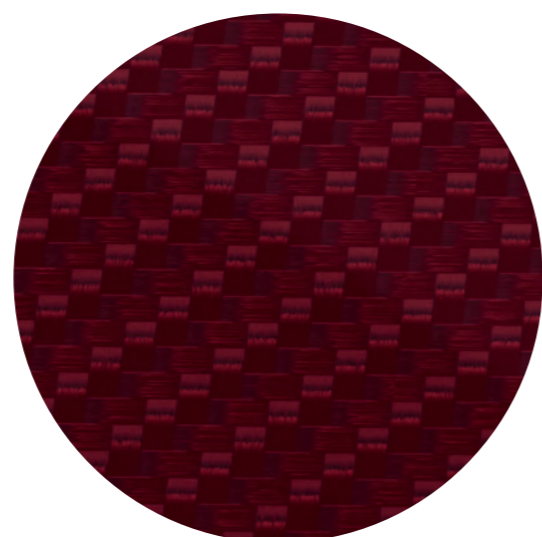

Ruby Red

Real fabric size.
Different colours also available on demand.

Design by IXO®. Made in Spain.

The product images shown may represent the range of product, or be for illustration purposes only and may not be an exact representation of the product. IXO reserves the right to change product design and/or images at any time without notice. All product company names are trademarks™ or registered® trademarks of their respective holders. Use of them does not imply any affiliation with or endorsement by them.



At IXO, good is never enough. We strive for perfection and the goal of ultimate quality in every aspect, and that is a moving target. Whether it is beauty, luxury, elegance, exclusivity or durability, we make sure to raise the bar.

All available time, emotion, knowledge and resources have been spent. Nothing has been spared – everything has been ventured and sacrificed – in order to create a being beyond imagination.

I truly feel that our creations have soul. We have poured our hearts into them.”

Pedro Sánchez
General Manager

impossible
furniture



ixocarbon.com